

GCE

QUICK GUIDE

This document is a concise version of the model manual. This document is not meant to be a replacement of the manual. To download the full manual please scan the QRcode below or locate the data label on the model and scan the QRcode.

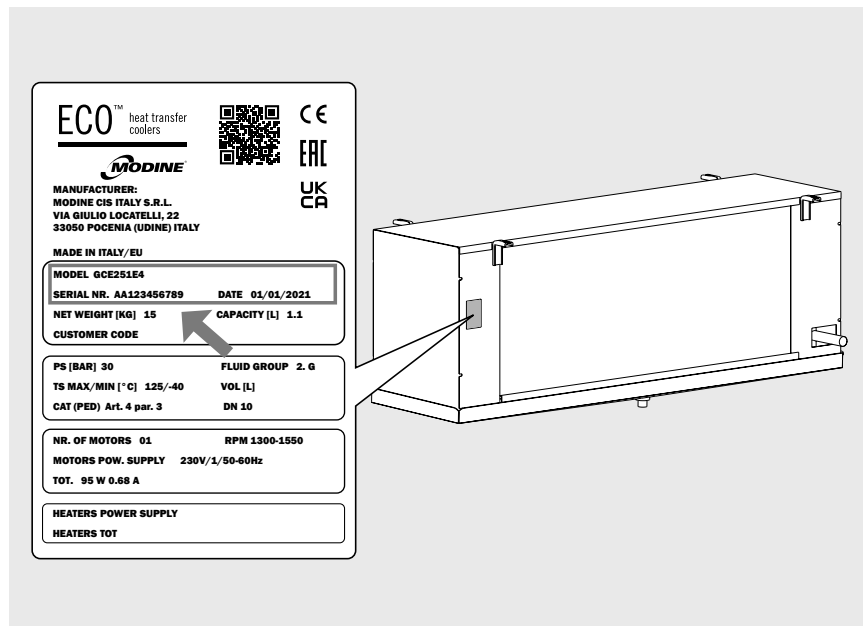

Link to user manuals:

IT ES
EN FR
DE RU

! Before removing the packaging, handling, assembling, positioning, commissioning of the machine and before performing any work on the model, download and carefully read all the information in the manual. If in doubt contact Modine.

Construction and dimensional features

Ø250 fan diameter unit

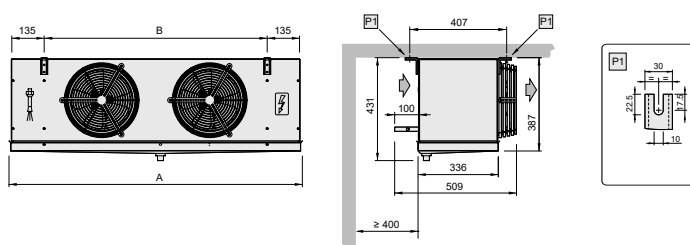

Ø315 fan diameter unit

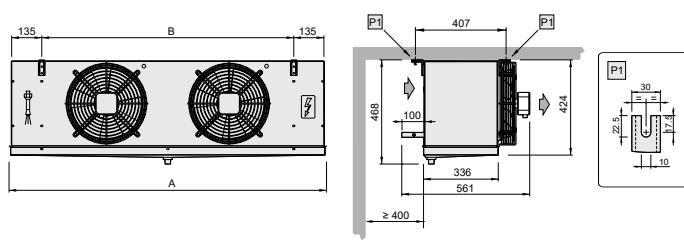

Model	GCE	251E4R	251E4	252G4	252E4	253G4	253E4	254G4	254E4	311F4	312F4	313F4	314F4
		251E6R	251E6	252G6	252E6	253G6	253E6	254G6	254E6	311F6	312F6	313F6	314F6
		251E8R	251E8	252G8	252E8	253G8	253E8	254G8	254E8	311F8	312F8	313F8	314F8
Motorfans	n° x Ø mm	1x250	1x250	2x250	2x250	3x250	3x250	4x250	4x250	1x315	2x315	3x315	4x315
Dimensions	A [mm]	674	774	1224	1224	1674	1674	2124	2124	874	1424	1974	2524
	B [mm]	380	480	930	930	1380	1380	1830	1830	580	1130	1680	2230
Coil connections	In [mm]	12	12	12	12	12	12	12	16	12	12	16	16 (F4: 22)
	Out [mm]	12	12	22	22	22	22	22 (G4:28)	28	22	28	28	28 (F8: 35)
Drain connection	Ø (GAS)	1"	1"	1"	1"	1"	1"	1"	1"	1"	1"	1"	1"
Net weight	kg	13	14.5	21.5	24	30	33	38	41.5	20	34	47.5	61

Ø350 fan diameter unit

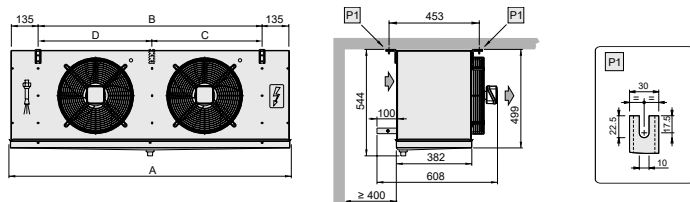

Model	GCE	351E4	351A4	352E4	352A4	353F4	353A4	354F4	354A4	355A4
		351E6	351A6	352E6	352A6	353F6	353A6	354F6	354A6	355A6
		351E8	351A8	352E8	352A8	353F8	353A8	354F8	354A8	355A8
Motorfans	n° x Ø mm	1x350	1x350	2x350	2x350	3x350	3x350	4x350	4x350	5x350
Dimensions	A [mm]	875	875	1425	1425	1975	1975	2525	2525	3075
	B [mm]	580	580	1130	1130	1680	1680	2230	2230	2780
	C [mm]	-	-	-	-	-	-	1115	1115	1665
	D [mm]	-	-	-	-	-	-	1115	1115	1115
Coil connections	In [mm]	12	12	16	16	16 (F4: 22)	22	22	28	28
	Out [mm]	22	22	28	28	28 (F8: 35)	35	35 (F8: 42)	42	42
Drain connection	Ø (GAS)	1"	1"	1"	1"	1"	1"	1"	1"	1"
Net weight	kg	22	26.5	41	48	58	63	77	83.5	103

Use thermostatic valve with external pressure equalizer

Wiring diagrams

Motor-fan connection diagram

Important. The motors are equipped with inner thermal protection with automatic reconnection. Before using motor speed control systems verify the compatibility with the motors. Non compatible systems may damage motors or increase noise level; Modine will not be responsible for model performance with speed control systems. For fans equipped with thermal contacts (TK), these must be connected to the control circuit. For models supplied with wiring in a junction box, remove the cover to make the connection.

Model	GCE	251E4R	251E4	252G4	252E4	253G4	253E4	254G4	254E4
		251E6R	251E6	252G6	252E6	253G6	253E6	254G6	254E6
		251E8R	251E8	252G8	252E8	253G8	253E8	254G8	254E8
Motorfans	n° x Ø mm	1x250		2x250		3x250		4x250	
Frequency	Hz	50	60	50	60	50	60	50	60
Electrical consumption	A	0.66	0.66	1.32	1.32	1.98	1.98	2.64	2.64
	W	95	95	190	190	285	285	380	380
RPM		1300	1400	1300	1400	1300	1400	1300	1400

Model	GCE	311F4		312F4		313F4		314F4	
		311F6		312F6		313F6		314F6	
		311F8		312F8		313F8		314F8	
Motorfans	n° x Ø mm	1x315		2x315		3x315		4x315	
Frequency	Hz	50	60	50	60	50	60	50	60
Electrical consumption	A	0.52	0.66	1.04	1.32	1.56	1.98	2.08	2.64
	W	110	148	220	296	330	444	440	592
RPM		1350	1490	1350	1490	1350	1490	1350	1490

Model	GCE	351E4	351A4	352E4	352A4	353F4	353A4	354F4	354A4	355A4
		351E6	351A6	352E6	352A6	353F6	353A6	354F6	354A6	355A6
		351E8	351A8	352E8	352A8	353F8	353A8	354F8	354A8	355A8
Motorfans	n° x Ø mm	1x350		2x350		3x350		4x350		5x350
Frequency	Hz	50	60	50	60	50	60	50	60	60
Electrical consumption	A	0.96	1.08	1.92	2.16	2.88	3.24	3.84	4.32	5.40
	W	185	250	370	500	555	750	740	1000	1250
RPM		1450	1700	1450	1700	1450	1700	1450	1700	1700

Ø250 fan diameter unit

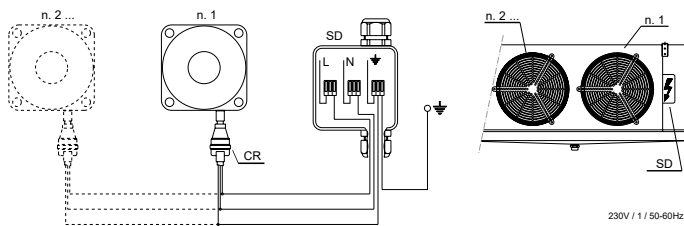

- = yellow-green
- L = brown or grey
- N = blue
- CR = cable quick connection
- SD = junction box

Ø315-Ø350 fan diameter unit

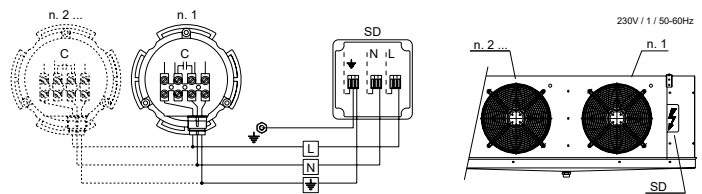

- = yellow-green
- L = brown
- N = blue
- SD = junction box



Modine CIS Italy S.r.l.
 33050 Pocenia - Udine - Italy
 Via Giulio Locatelli, 22
 Tel. +39 0432.772.001
 Fax +39 0432.779.594
 www.modine.com

Link to user manuals:

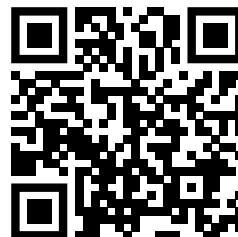

<https://www.modinecoolers.com/documents/>