



# TRANSFORMER OIL COOLER ALFA

Coiltech<sup>®</sup> industrial  
heat transfer



A03

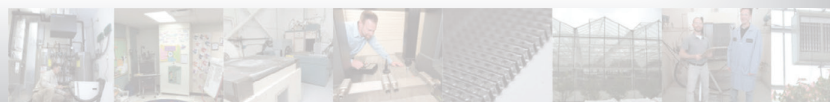

# TRANSFORMER OIL COOLER ALFA

The transformer oil cooler ALFA is used to cool power transformers by means of forced air and oil flow.

The oil in the cooler is circulated using a pump (can be ordered separately).

The ALFA transformer oil cooler is delivered as a fully factory-assembled unit. Each cooler consists of a casing with a finned tube heat exchanger with one or two fan units. When two fan units are used, the fans are separated by a partition wall. This permits each fan to be enabled or disabled to give incremental power regulation as the cooling need changes.

The ALFA cooler is designed with one or two fan units for horizontal or vertical installation.

The cooler is designed to withstand vibrations, shocks, seismic forces and thermal movements.

## OIL FORCED/AIR FORCED

The Modine transformer oil cooler concept, type Oil Forced Air Forced (OFAF), offers many benefits including:

- Pre-designed with simple ordering product code
- High cooling capacity
- Horizontal or vertical installation design
- Thoroughly cleaned inside by oil flushing
- Different materials available
- Computer program COILS available for correct sizing

## TECHNICAL DATA ALFA

Max operating pressure 0.35 MPa (e)

Test pressure 0.5 MPa (e)

Max operating temperature 100 °C

## FINNED HEAT EXCHANGER

The cooler is made of aluminium tubes mounted in a bundle of aluminium plate fins. The fins on the tubes give an increased heating surface as to compensate for the low heat transfer coefficient on the air side. The continuous arrangement of the fins in the air flow direction and the wide fin pitch provide good resistance against clogging.

When the number of liquid passes is three, each header is fitted with partition walls to make the required cross-flow circuit, relative to the air flow. It's also equipped with two drain or venting plugs.

The removable headers made of anti-corrosion coated steel are sealed to the tube plates by use of an O-ring gasket. The tubes are mechanically expanded into the fins as to give absolute contact between the tubes and fins for the best heat transfer. The tubes can be equipped with turbulator inserts to increase the capacity of the cooler. To avoid damages of the finned surface, there is a protection guard available as an option.

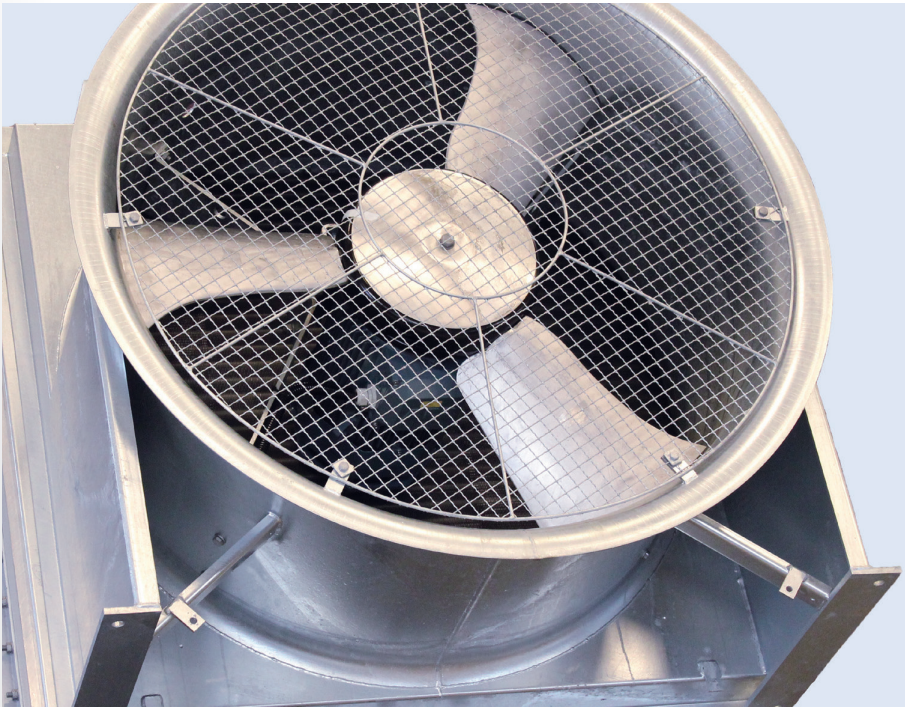

Single fan cooler ALFA-1 for horizontal or vertical installation.

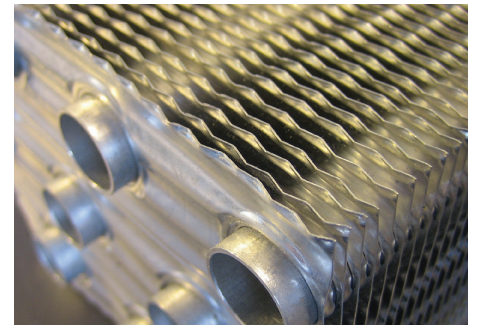

The tubes are mechanically expanded into the fins.



When two fan units are used, the fans are separated by a partition wall to give incremental power regulation.

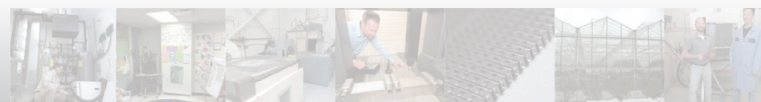



Double fan cooler ALFA-2 for horizontal airflow.



Modine transformer oil coolers are compatible with most power transformer projects worldwide.

## FAN UNIT

The cooler is equipped with direct driven fans, with blowing forced fan arrangement. The fans are available in different speeds, depending on the sound requirements. The impeller blades are made of cast aluminium and the hub is made of anti-corrosion coated steel. The impeller is balanced according to ISO-1940/1.

The fan is driven by a totally enclosed, three-phase, squirrel-cage induction motor with protection class IP 55 and F-insulation. The motor is delivered with open drainage as the cooler shall be installed outdoors.

The casing is made of hot-dip galvanized sheet steel and is provided with lifting lugs as well as brackets, in order to fit the cooler to the transformer. The fan protection guard, fixed with the fan, can easily be removed for inspection or when replacement of the fan or motor is required.

## TRANSFORMER OIL CIRCULATION PUMP TYPE VMOA

can be supplied by Modine.

The pump has an integrated motor and is highly efficient, cooled and lubricated by the transformer oil, robust, reliable and maintenance free.

The sound level is also low.

The pump can be supplied in two different sizes and with varying flow rates.

## CLEANLINESS & PACKING

Before delivery each cooler is carefully cleaned inside by flushing with transformer oil, with an on-line particle counter to ensure it meets the requirements for cleanliness for power transformer applications in acc. with ISO 4406, 10/7 (correlated to NAS 1638 class 1). The oil connections are sealed off and tightened for shipment.

The coolers are delivered bolted to a wooden pallet, but separate wooden boxes or alternative packing options are also available upon request. A protective plastic wrapping covers the fan unit. The oil connections of the heat exchanger are covered.



Modine's management system is certified according to ISO 9001:2015, ISO 14001:2015 and ISO 3834-2:2005.



# TECHNICAL DATA

Data presented below are for capacity variant d - e = 3 - 1. For selection of other capacity variants, presented in the ordering key, please use our computer selection program COILS.

## Technical data – 50 Hz

Type of ALFA cooler	No of poles	Fan speed (rpm)	Cooling capacity at T=30K <sup>1)</sup> (kW)	Sound pressure level <sup>2)</sup> (dBA)	Sound power level <sup>3)</sup> (dBA)	Airflow (m <sup>3</sup> /s)	Pump VMOA size	Oil flow (l/s)	Temp drop (K) <sup>4)</sup>	Pressure drop (kPa)
Single	8	725	164	75	91	9,2	188	21	4,7	45
Double	8	725	316	78	94	18,4	218	21	8,8	92
Single	10	550	143	69	85	6,8	188	21	4,0	45
Double	10	550	278	72	88	13,6	218	21	7,6	92
Single	12	475	127	66	82	5,7	188	21	3,6	45
Double	12	475	250	69	85	11,4	218	21	6,8	92
Single	16	355	103	59	75	4,1	188	21	2,8	45
Double	16	355	202	62	78	8,2	218	21	5,6	92

## Technical data – 60 Hz

Type of ALFA cooler	No of poles	Fan speed (rpm)	Cooling capacity at T=30K <sup>1)</sup> (kW)	Sound pressure level <sup>2)</sup> (dBA)	Sound power level <sup>3)</sup> (dBA)	Airflow (m <sup>3</sup> /s)	Pump VMOA size	Oil flow (l/s)	Temp drop (K) <sup>4)</sup>	Pressure drop (kPa)
Single	10	690	156	74	90	8,7	182	21	4,8	45
Double	10	690	303	77	93	17,4	188	21	8,4	92
Single	12	565	140	70	86	7,0	182	21	3,8	45
Double	12	565	272	73	89	14,0	188	21	7,4	92
Single	16	425	115	63	79	5,0	182	21	3,2	45
Double	16	425	228	66	82	10,0	188	21	6,2	92

- 1) T=30K means a mean oil temperature rise of 30K above ambient air temperature of 20 °C, 1013 kPa. The specific heat for the insulating oil used during heat test is 1988 J/kg, K at 50 °C.
- 2) Sound pressure level measured according to IEC 551 (distance 2m).
- 3) Sound power level measured according to ISO 3744.
- 4) Difference between oil inlet and outlet temperature.

## Motor data - Single & Double fan cooler

Hz	No of poles	Voltage (V)	Conn.	Fan speed (Rpm)	Rated power output (Kw)	Rated current (A)	Max current (A)
50	8	400	D	725	5,5	15,4	18,9
	10	400	Y	570	2,4	8,6	10,6
	12	400	Y	475	1,5	6,4	7,9
	16	400	Y	360	0,7	5,3	6,5
60	8	480	D	865	8,6	17,4	21,4
	10	480	Y	690	3,9	9,5	11,7
	12	480	Y	590	3,2	12,2	15,0
	16	480	Y	430	1,1	5,1	6,3

## Cooling capacity - Single & Double fan cooler

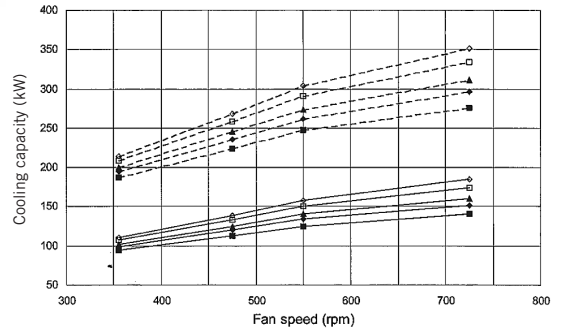

- Oil flow 15 l/s ◆ Oil flow 17,5 l/s ▲ Oil flow 20 l/s □ Oil flow 25 l/s ◇ Oil flow 30 l/s
- Cooling capacity of one Single or Double transformer Cooler at a mean oil temperature rise of 30 K above ambient air temperature of 20°, 1013 kPa.

## Oil pressure drop - Single fan cooler, ALFA-1

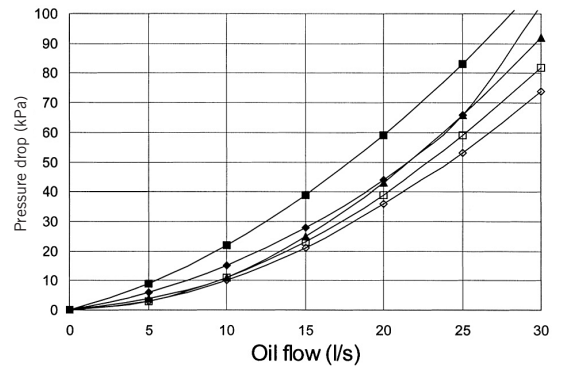

- 0°C ◆ 20°C ▲ 40°C □ 60°C ◇ 80°C
- Pressure drop in one Single Transformer Cooler att different mean oil temperatures.

## Oil pressure drop - Double fan cooler, ALFA-2

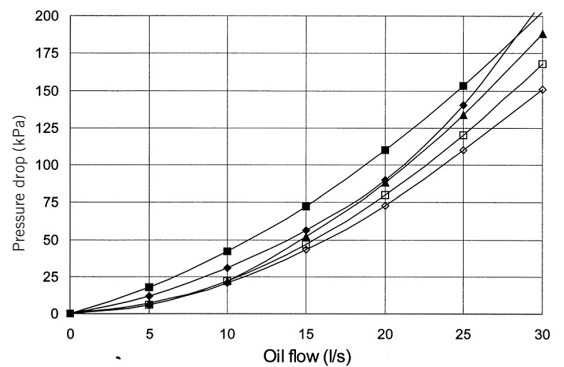

- 0°C ◆ 20°C ▲ 40°C □ 60°C ◇ 80°C
- Pressure drop in one Double Transformer Cooler att different mean oil temperatures.



# MOUNTING ARRANGEMENTS

## Mounting arrangements – all arrangements with blowing fans

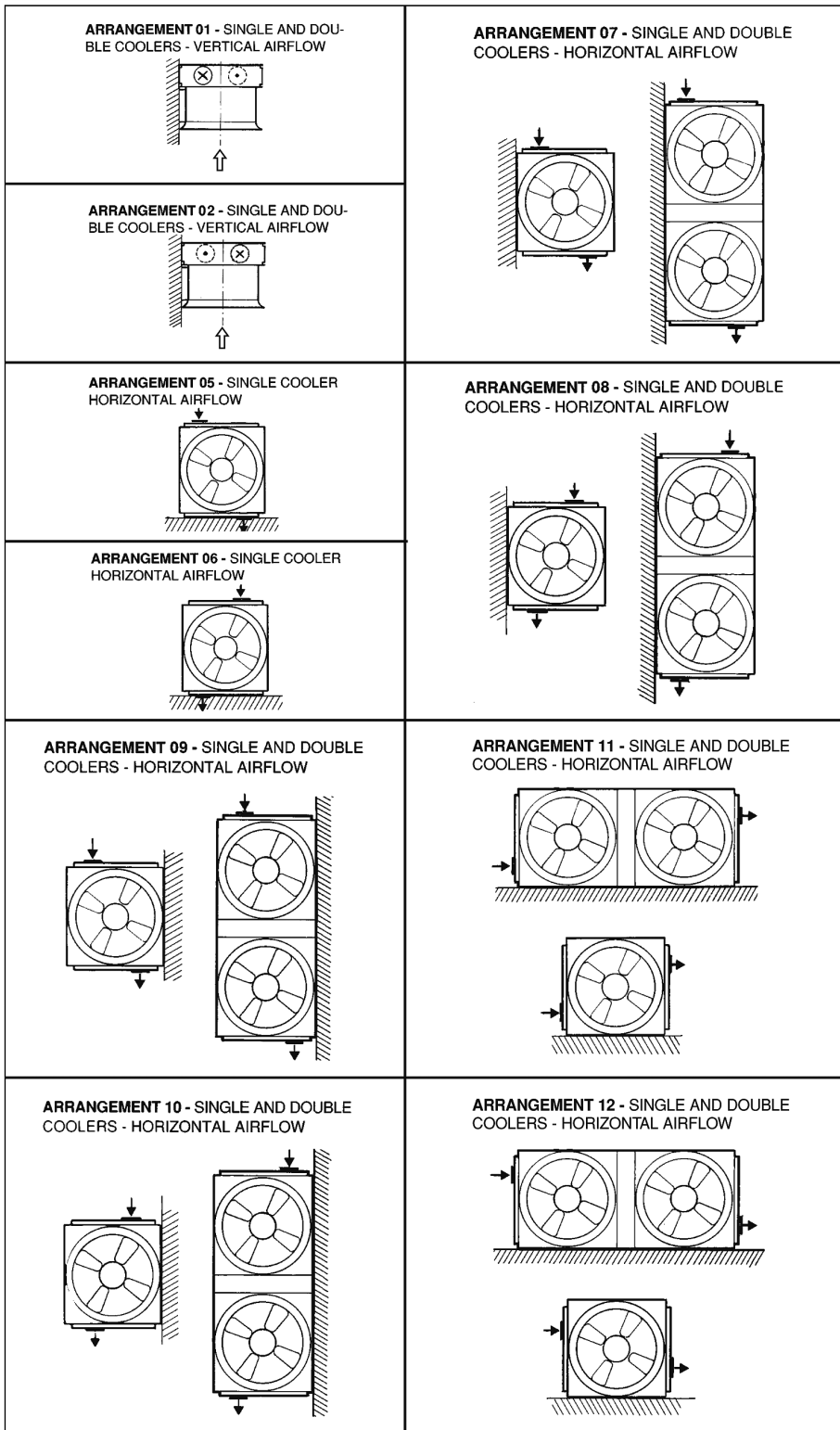

### Computer selection program COILS

The ALFA transformer oil cooler is available in a wide range of configurations. Modine's computer program COILS is used to select and size the correct cooler. The program is a reliable and flexible program and generates a print-out of technical data and a dimensional drawing of the selected cooler. Some variables to be considered while sizing and selecting include:

- Cooling capacity
- Oil flow rate & temperatures
- Fan motor power supply
- Ambient temperature
- Environmental conditions
- Sound level (fan speed)
- Cooler size
- Number of fans
- Number of oil passes
- With or without turbulators
- Mounting alternative

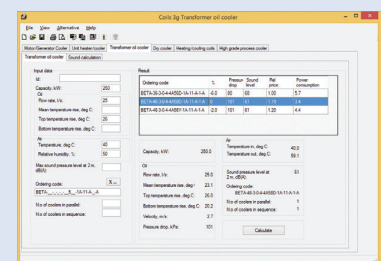

Contact us and we can supply the COILS program to you or help you in selecting the optimal cooler.



# MATERIAL, PRODUCT CODE KEY & ACCESSORIES

## MATERIAL

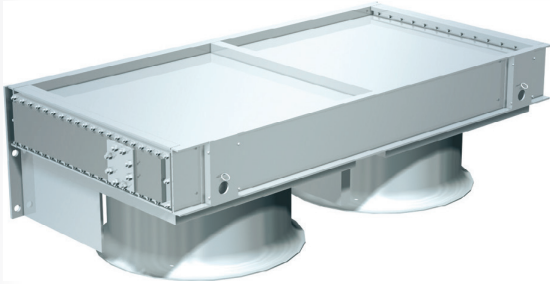

1. **Tubes** – Aluminium, AA 3103 F13
2. **Tube plates** – Aluminium, EN AW-6082-T651
3. **Fins** – Aluminium, AA 8011-H24
4. **Headers** – Rilsan coated steel
5. **Casing** – Hot dipped galvanized steel, Fz acc. to EN ISO 1461
6. **Fan impeller** – Cast aluminium blades. Anti corrosion coated steel hub.
7. **Electric motor** – Cast aluminium - IP 55/IEC 34-1 with open drain holes.

## CODE KEY

### ALFA-a-bbbb-cc-d-e-2

#### a = Cooler size

- a = 1 = single fan cooler, one fan
- a = 2 = double fan cooler, two fans

#### bbbb = Motor data (frequency/number of poles):

- 50 Hz: 5006, 5008, 5010, 5012, 5016
- 60 Hz: 6008, 6010, 6012, 6016

#### cc = Mounting arrangements, see page 7

#### d = Number of oil passes: 1, 2 or 3

#### e = Turbulator inserts

- 0 = without inserts
- 1 = turbulator inserts in 1/3 of the tubes
- 2 = turbulator inserts in 2/3 of the tubes
- 3 = turbulator inserts in all tubes

#### 2 = Internal design code

## ACCESSORIES

ALFZ-03-bb Fin surface protection grid, see picture.  
bb = 1 = one fan. bb = 2 = two fans.

ALFZ-04-01 Angle flange, see picture.

## OTHER OPTIONS ON REQUEST

- Fan motors for other power supply voltage.
- Safety switch
- Terminal box
- Painting for esthetic reasons
- With or without turbulator inserts into the heat exchanger tubes for increased efficiency.
- Transformer oil circulation pump type VMOA, see page 3.
- Different packing depending on mode of shipment.
- Low temperature options, to -45 °C.

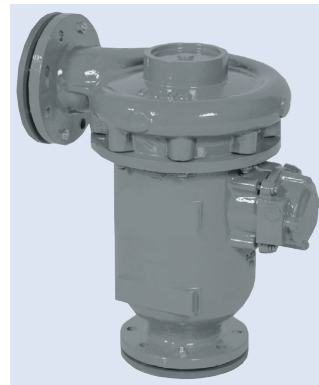

Oil circulation pump type VMOA.

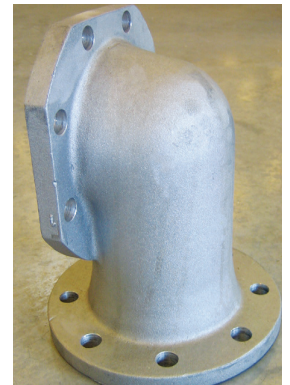

Angle flange, ALFZ-04-01.

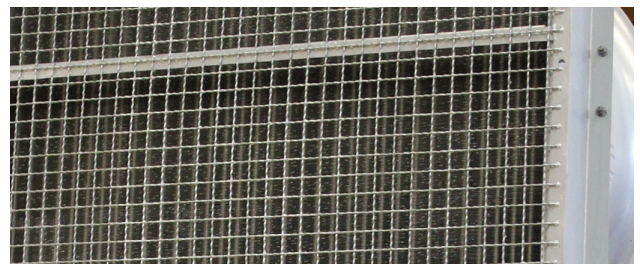

Fin surface protection grid, mounted on cooler air outlet side, ALFZ-03-bb.

## SPECIAL DESIGN

We have a wide range of standard products, but if your application need a cooler that need special requirements, such as corrosion protection, special materials or installation in limited spaces, a special design may be the best solution. Contact us for more information.

# DIMENSIONS & WEIGHTS

## Single fan cooler, ALFA-1

Weight dry=685 kg, volume internal=76 l

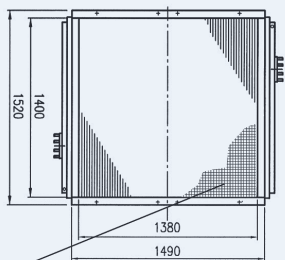
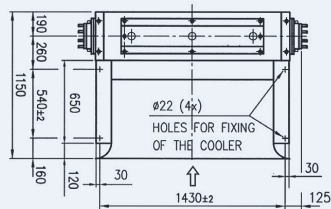
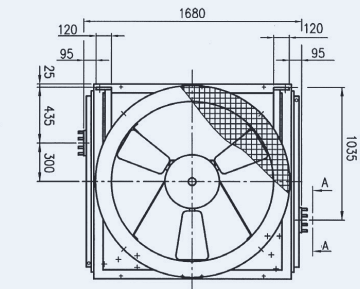

Protection guard  
ALFZ-03-01

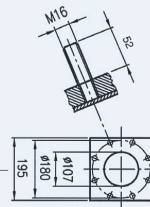

## Double fan cooler, ALFA-2

Weight dry=1285 kg, volume internal=130 l

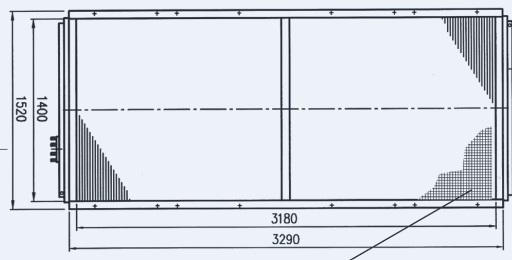
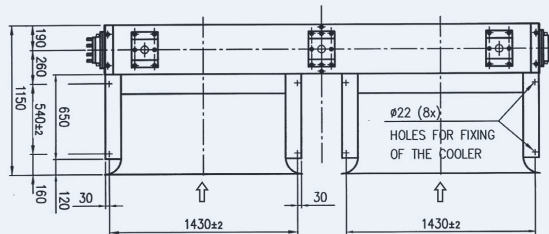
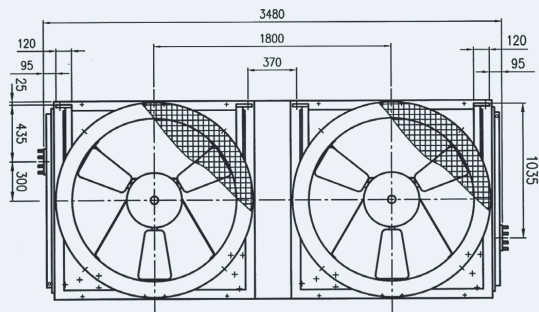

Protection guard  
ALFZ-03-02

## ALFZ-04-01 Angle flange

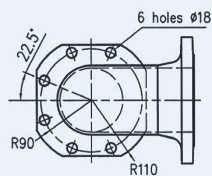

The flanges are provided with grooves for O-rings.

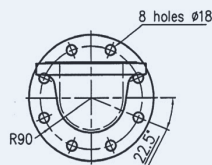
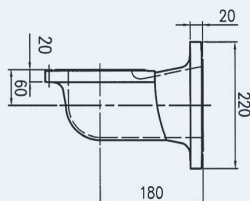



To learn more, visit  
[www.modine.com](http://www.modine.com)

 Follow us @ModineHVAC  
 See us at [YouTube.com/ModineHVAC](https://www.youtube.com/ModineHVAC)

ALPC1812A06EP\_U

©2018 Modine Manufacturing Co.

#### About Modine

Modine specializes in thermal management systems and components, bringing highly engineered heating and cooling components, original equipment products, and systems to diversified global markets through its three complementary business units: Vehicular Thermal Solutions (VTS); Commercial & Industrial Solutions (CIS); and Building HVAC Systems (BHVC).

Modine is a global company headquartered in Racine, Wisconsin (USA), with operations in North America, South America, Europe, Asia and Africa.

#### Contacts:

##### Sweden

Industrigatan 2  
SE-614 81 Söderköping, Sweden  
Tel +46 121.191.00  
[inquiry-sodese@modine.com](mailto:inquiry-sodese@modine.com)

##### Italy

Via Giulio Locatelli, 22  
33050 Pocenia (UD), Italy  
Tel +39 0432.772.001

##### Belgium

Poortakkerstraat 41  
B - 9051 Sint-Denijs-Westrem - Belgium

##### PRC

No. 19 Xin Nan Zhong Road,  
Mei Cun, Wuxi New District  
Wuxi 214112 Jiangsu  
Tel +86 510.8855.3982

##### USA

PO Box 1457, 1000 Heatcraft Dr.  
Grenada, MS 38902  
Tel +1 662.229.4116  
Fax +1 662.229.2002

